



**M727xSP**  
**PoE Powered**  
**Ethernet Media Converter**  
**10/100BASE-TX TO 100BASE-SX/LX**  
**Installation Guide**

© September 2009

**VERSITRON, Inc.**  
**83 Albe Drive - Suite C**  
**Newark, DE 19702**  
[www.versitron.com](http://www.versitron.com)

The information contained in this document is subject to change without prior notice. Copyright (C)  
All Rights Reserved.

## **TRADEMARKS**

Ethernet is a registered trademark of Xerox Corp.

## **FCC NOTICE**

This device complies with Class B Part 15 the FCC Rules. Operation is subject to the following two conditions: (1) This device may not cause harmful interference, and (2) this device must accept any interference received including the interference that may cause.

## **CE NOTICE**

Marking by the symbol indicates compliance of this equipment to the EMC directive of the European Community. Such marking is indicative that this equipment meets or exceeds the following technical standards:

EMC Class B

EN 61000-6-3/2001:

EN55022:98/A1:2000/A2:2003 Class B

EN61000-3-2:2000

EN61000-3-3:1995/A1:2001

EN 55024:1998/A1:2001/A2:2003

IEC 61000-4-2:2001

IEC 61000-4-3:2002/A1:2002

IEC 61000-4-4:1995/A1:2000/A2:2001

IEC 61000-4-5:2001

IEC 61000-4-6:1996/A1:2001

IEC 61000-4-11:2001

## PROPRIETARY DATA

All data in this manual is proprietary and may not be disclosed, used or duplicated, for procurement or manufacturing purposes, without prior written permission by **VERSITRON**.

## VERSITRON LIFETIME WARRANTY

All VERSITRON products are covered by a **Lifetime Warranty** against defects in materials and workmanship. This coverage is applicable to the original purchaser and is not transferable.

We repair, or at our option, replace parts/products that, during normal usage and operation, are proven to be defective during the time you own the products, provided that said products and parts are still manufactured and/or available. Such repair/replacement is subsequent to receipt of your product at our facility and our diagnostic evaluation and review of the unit. **Advance replacements are not provided as part of the warranty coverage.**

This warranty does not cover damage to products caused by misuse, mishandling, power surges, accident, improper installation, neglect, alteration, improper maintenance, or other causes which are not normal and customary applications of the products and for which they were not intended. No other warranty is expressed or implied, and VERSITRON is not liable for direct, indirect, incidental or consequential damages or losses.

In the unlikely event a warranty issue should arise, simply contact us at 302-894-0699 or 1-800-537-2296 or via email at [fiberlink@versitron.com](mailto:fiberlink@versitron.com) to obtain a Return Material Authorization (RMA) number, along with instructions for returning your product.

Note: This warranty is effective for commercial products as of January 1, 2001 and for GSA products as of July 1, 2006.

# Table of Contents

<b>1. Introduction.....</b>	<b>5</b>
1.1 Key Features .....	5
1.2 Specifications.....	6
1.3 Special Functions .....	10
1.3.1 Auto MDI/MDI-X Function.....	10
1.3.2 Auto-negotiation Function.....	10
1.3.3 Far End Fault Function .....	10
1.3.4 Link Fault Pass Through Function .....	11
1.3.5 Remote TP Port Monitoring Function .....	12
1.3.6 Loop Back Test Function .....	12
<b>2. Installation .....</b>	<b>13</b>
2.1 Unpacking.....	13
2.2 Safety Cautions .....	13
2.3 Mounting the Device .....	14
2.4 Powered by PoE over Cat.5 .....	15
2.5 Powered by External Power Adapter.....	16
2.6 Making TP Port Connection.....	17
2.7 LED Indicators .....	18
2.8 Performing Loop Back Test .....	19
<b>3. Optional Configuration Settings .....</b>	<b>20</b>
3.1 User Inaccessible Jumpers.....	20
3.1.1 Forwarding Mode Setting JP1 .....	21
3.1.2 802.3x Function Setting JP2.....	22
3.1.3 FX Duplex Setting JP3.....	22
3.2 JP1-JP3 Factory Default Settings.....	22

# 1. Introduction

---

The M727xSP 10/100BASE-TX to 100BASE-FX media converter series provides a media conversion allowing high-speed integration of fiber optic and twisted-pair segments. With 10BASE-T and 100BASE-TX support, the converters provide seamless translation between Ethernet and Fast Ethernet networks. A complete set of LEDs allows for quick status verification. Because of 802.3af compliance, the converters can draw the power via Cat.5 cable connected to a PoE PSE switch or mid-span injector in addition to being powered by typical external power adapter. This feature makes the converter ideal for remote areas of a network without AC power outlets.



## 1.1 Key Features

- Convert speed and media type with full wire speed conversion
- Support 10Mbps and 100Mbps speed on TP connections
- Auto-negotiation and auto MDI/MDI-X detection function
- Link fault pass through function
- Provide manual configuration settings for TP port to support connection to non-auto-negotiation devices
- Transparent to 802.1Q VLAN tagged packets
- Far End Fault function on FX port
- **Provide LED status display for remote TP port monitoring**
- **Provide Loop Back Test function for installation diagnostics**
- Support wide range of fiber options on the FX port
- Provide user-inaccessible settings for specific system applications
- IEEE 802.3af compliant PoE PD (Powered Device) design
- Low power consumption

## 1.2 Specifications

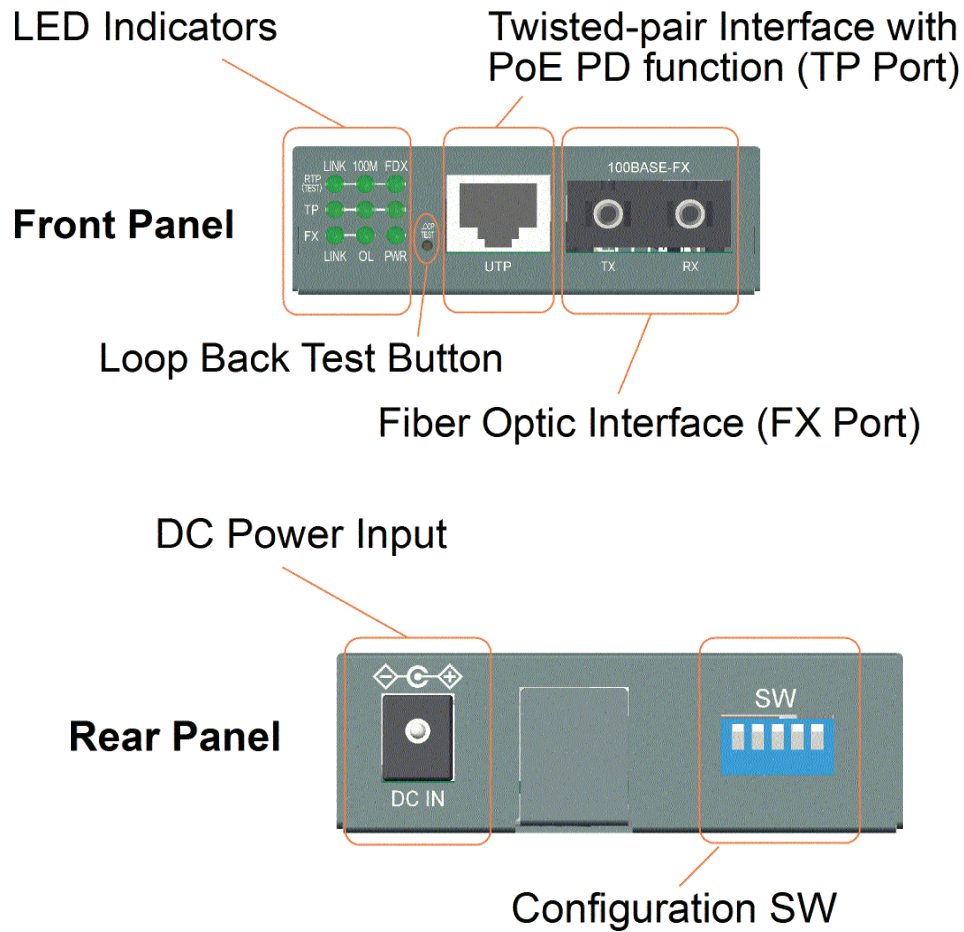

### Twisted-Pair Interface (TP Port)

Connector	Shielded RJ-45	
Pin Assignments	Auto MDI/MDI-X detection	
Signal Compliance	IEEE 802.3 10BASE-T, 802.3u 100BASE-TX	
Data Speed	10Mbps or 100Mbps	
Duplex Mode	Half-duplex or Full-duplex	
Configuration	Auto-negotiation capable and optional	forced manual settings
Cable Types	10Mbps - Category 3, 4, or 5 UTP	
	100Mbps - Category 5 UTP	
Supported Link Distance	Up to 100 meters	

### **Fiber Optic Interface (FX Port)**

Signal Compliance	IEEE 802.3u 100BASE-FX
Connector	SC, ST, LC or Single SC
Data Speed	100Mbps
Duplex Mode	Full-duplex and optional half duplex
Cable Types	Multi-mode (MMF) - 50/125, 62.5/125 $\mu\text{m}$ Single mode (SMF) - 9/125 $\mu\text{m}$
Supported Link Distance	MMF up to 2km SMF up to 100km Single SMF WDM up to 40km
Eye Safety compliance	IEC825 Class 1

### **Loop Back Test Button (LOOP TEST)**

PUSH	Start loop back test
RELEASE	Stop loop back test

### **User Accessible Settings (SW)**

<b>NO.</b>	<b>SETTING</b>	<b>STATE</b>	<b>FUNCTION</b>
SW1	TP Port Configuration	OFF	Auto-negotiation (default)
		ON	Forced mode
SW2	TP Port Duplex	OFF	Full duplex (default)
		ON	Half duplex
SW3	TP Port Speed	OFF	100Mbps (default)
		ON	10Mbps
SW4	Link Fault Pass Through	OFF	Disable (default)
		ON	Enable
SW5	Auto-status-report	OFF	Disable (default)
		ON	Enable

### **Optional Settings (User inaccessible JP1-JP3 on board)**

<b>NO.</b>	<b>SETTING</b>	<b>STATE</b>	<b>FUNCTION</b>
JP1	Forwarding mode	Open	Store-and-forward (default)
		Short	Smart-forward mode
JP2	802.3x function	Open	Enable (default)
		Short	Disable
JP3	FX port duplex	Open	Full duplex mode (default)
		Short	Half duplex mode

### **LED Indicators**

<b>LED</b>	<b>DISPLAY</b>	<b>STATE</b>	<b>INTERPRETATION</b>
PWR	Power status	ON	Power on
		OFF	Power off
TP LINK	TP port link status	ON	Link up and no traffic
		OFF	Link fault
		Blink	Rx/Tx activities
TP 100M	TP port speed status	ON	100Mbps
		OFF	10Mbps
TP FDX	TP port duplex status	ON	Full duplex
		OFF	Half duplex
		Blink	Collisions on half duplex
FX LINK	FX port link status	ON	Link up and no traffic
		OFF	Link fault
		Blink	Rx/Tx activities
FX OL	FX port optical link	ON	Optical signal is detected
		OFF	No optical signal
RTP LINK	Remote TP port link	ON	Link up and no traffic
		OFF	Link fault
RTP 100M	Remote TP port speed	ON	100Mbps
		OFF	10Mbps
RTP FDX	Remote TP port duplex	ON	Full duplex
		OFF	Half duplex

RTP LINK/100M/FDX LEDs are also used for loop back test report.

### **PoE (Power over Ethernet)**

Standard	IEEE 802.3af PD (Powered Device)
Power Reception	TP port RJ-45 Pin 1,2,3,6 or Pin 4,5,7,8
Input Voltage	36 ~ 57VDC via Cat.5
Power Classification	Class 1

### **DC Power Input**

DC Input Jack	D 6.3mm  D 2.0mm
Operating Input Voltages	+6.7V ~ +57V
Power Consumption	2W max. (0.27A @+7.5V)



Power Supply Options	External AC-DC power adapters Input options: AC 100V/120V/230V/240V Rated output: DC7.5V 500mA min.
Powered by USB	via USB-to-DC-Plug cable (optional) on DC input jack

### **Basic Information**

Forwarding Throughput	Full wire speed at 100M full duplex 10Mbps - 14,880 pps at 64-byte packets 100Mbps - 148,800pps at 64-byte packets
Packet Types	Transparent and no modification for - IEEE 802.3 standard packets - IEEE 802.1Q VLAN tagged packets
Packet Length	Up to 1522 bytes at store-and-forward mode No limit at smart-forward mode 100to100
Flow Control	Back-pressure for half-duplex mode 802.3x pause-frame base for full duplex mode

### **Mechanical**

Dimension	H 23mm x W 72.5mm x D 108mm
Housing	Enclosed metal with no fan
Mounting	Desktop, Wall mount, Optional - Din-Rail
Weight	212g

### **Environmental**

Operating Temperature	-5°C ~ 50°C
Storage Temperature	-20°C ~ 85°C
Relative Humidity	5% ~ 90%

### **Certificate**

FCC	Part 15 Class B
CE/EMC	EMI EN50081-1 Class B, EMS EN55024
CE/LVD	EN 60950

## 1.3 Special Functions

### 1.3.1 Auto MDI/MDI-X Function

This function allows the TP port to auto-detect the twisted-pair signals and adapts itself to form a valid MDI to MDI-X connection with the remote connected device automatically.

### 1.3.2 Auto-negotiation Function

When TP port is set on Auto-negotiation mode (SW1: ON), it is featured with auto-negotiation function and full capability. It performs a negotiation process for the speed and duplex configuration with the connected device automatically when each time a link is being established.

### 1.3.3 Far End Fault Function

The FX port is facilitated with this function, which conforms to IEEE 802.3u 100BASE-FX specifications. When the FX port detects a link failure on its receiving circuitry, it will send out an FEFI (Far End Fault Indication) signal to the remote connected device to indicate a remote fault is detected. It also is capable to receive FEFI signal sent from the remote link partner. Upon receiving an FEFI signal, it indicates a link failure occurred on the transmitting path. This function allows the converter to report a fiber link fault even when a link failure occurred on transmitting fiber cable.

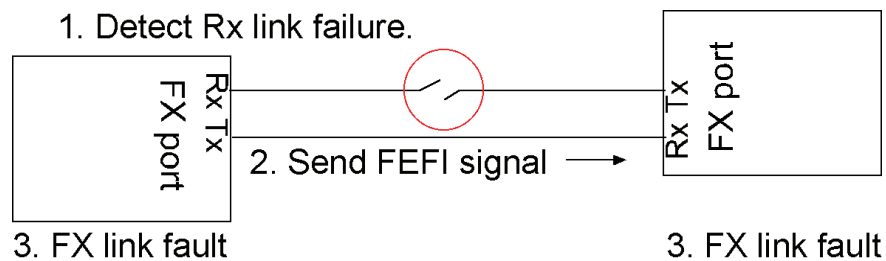

### 1.3.4 Link Fault Pass Through Function

When this function is enabled, a link fault detected on the TP port will force a link down on the FX port. Similarly, a link fault detected on the FX port will also force a link down on the TP port. As illustrated in the following figure, this function allows passing TP link fault to the remote link partner and makes the converter like a TP cable extender.

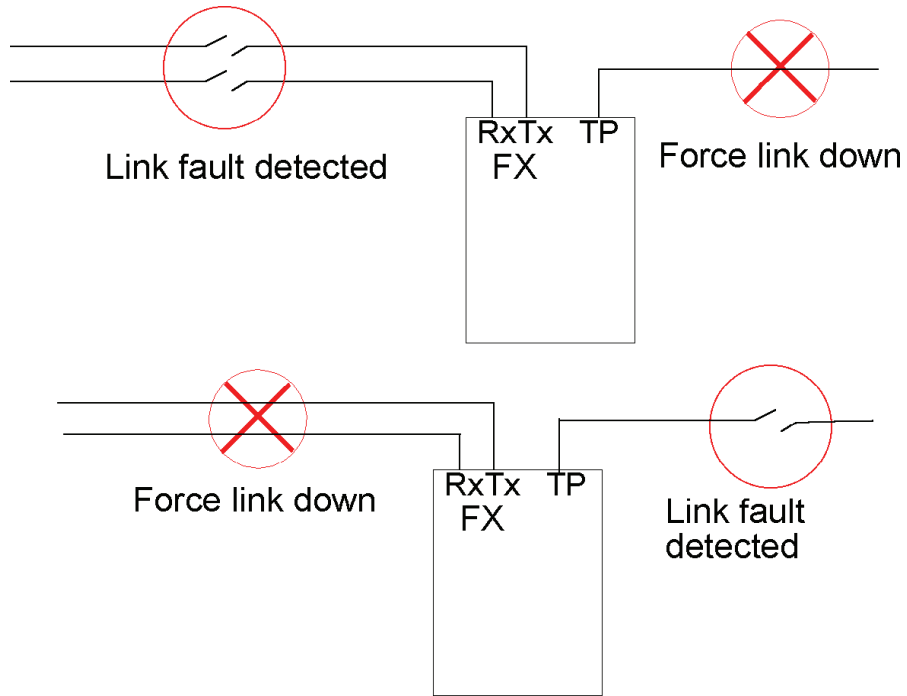

### 1.3.5 Remote TP Port Monitoring Function

The converter provides LED indicators labeled RTP LINK/100M/FDX to display the TP port status of its remote link partner on FX port. As illustrated in the following figure, the remote MC must be enabled for periodical status report.

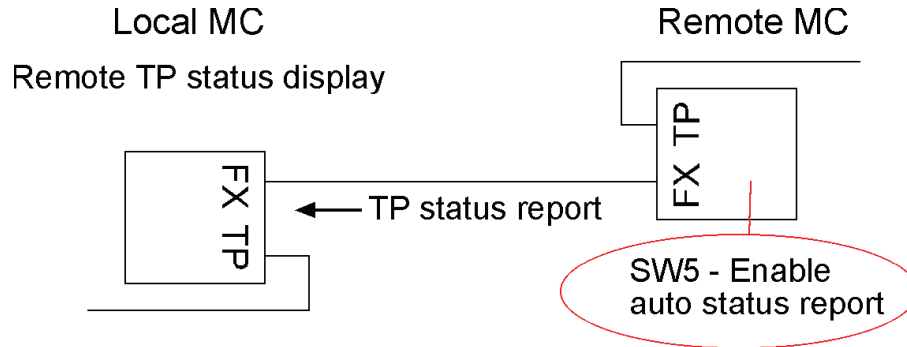

### 1.3.6 Loop Back Test Function

As illustrated in the following figure, the local MC starts a loop back test by pressing the loop back test button. It sends test frames from its FX port to the remote MC. The remote MC forwards the received test frames back to local MC from its FX port. The local MC verifies the loop back test frames and display the test result on RTP LINK/100M/FDX LEDs. This function can help installer to check the full path from a local MC through fiber to a connected remote MC and back to local MC.

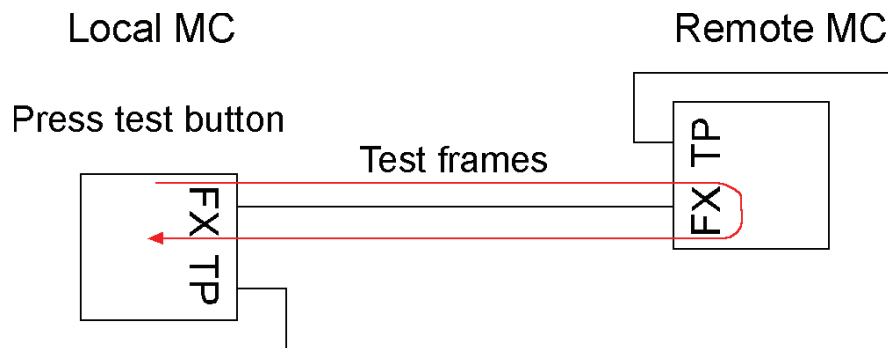

## 2. Installation

---

### 2.1 Unpacking

Check that the following components have been included:

- Installation guide (or contained in the product CD)
- 10/100 Media Converter

If any item is missing or damaged, please contact VERSITRON.

### 2.2 Safety Cautions

To reduce the risk of bodily injury, electrical shock, fires, and damage to the product, observe the following precautions.

- Do not service any product except as explained in your system documentation.
- Opening or removing covers may expose you to electrical shock.
- Only a trained service technician should service components inside these compartments.
- If any of the following conditions occur, unplug the product from the electrical outlet and replace the part or contact your trained service provider:
  - The power cable, extension cable, or plug is damaged.
  - An object has fallen into the product.
  - The product has been exposed to water.
  - The product has been dropped or damaged.
  - The product does not operate correctly when you follow the operating instructions.
- Do not push any objects into the openings of your system. Doing so can cause fire or electric shock by shorting out interior components.
- Operate the product only from the type of external power source indicated on the electrical ratings label. If you are not sure of the type of power source required, consult your service provider or local power company.

## 2.3 Mounting the Device

### Desktop Mounting

The media converter can be mounted on a desktop or shelf. Make sure that there is proper heat dissipation from and adequate ventilation around the device. Do not place heavy objects on the device.

### Wall Mounting

The media converter also can be mounted on a wall. On bottom of the device, wall mounting hole is provided for wall mounting.

Mounting hole on bottom case

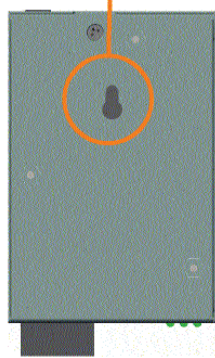

Mounting on a wall

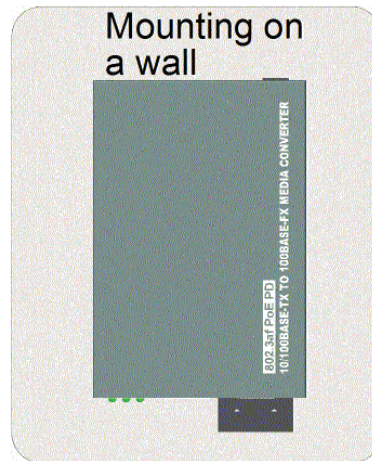

### Din-rail Mounting

For a Din-Rail chassis, the media converter can support mounting on a Din-Rail. An optional Din-Rail bracket, DRB can be purchased separately. The following figures show an example after bracket installation:



Din-Rail mounting bracket

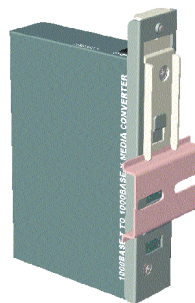

Din-Rail installation

## 2.4 Powered by PoE over Cat.5

### Power supply by a Mid-Span PoE Injector

The following figure illustrates the converter being powered by PoE delivered from a remote mid-span PoE injector over Cat.5.

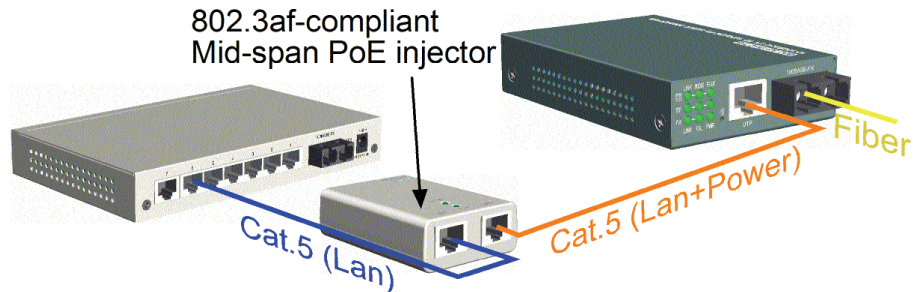

### Power supply by a PoE PSE Switched Port

The following figure illustrates the converter being powered by PoE delivered from a remote PoE PSE switch over Cat.5.

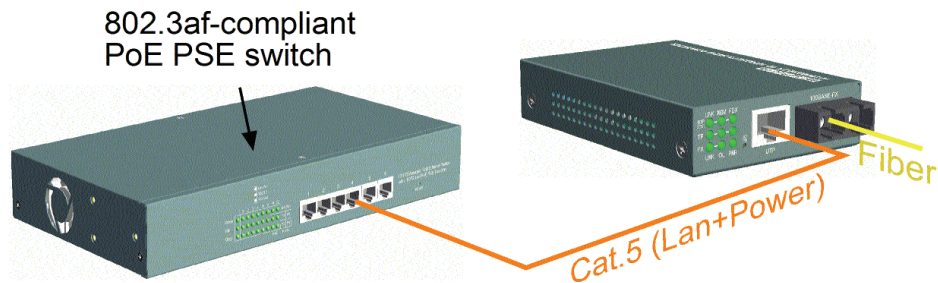

Note:

1. The Cat.5 used can be the standard Cat.5 cable for Ethernet connection.
2. Check the power LED on the converter to see whether the power is received on the Cat.5.
3. For compatibility, the remote PoE PSE used must be IEEE 802.3af compliant.

## 2.5 Powered by External Power Adapter

The converter can support being powered by an external power adapter as an alternative when PoE power is not available on Cat.5. Before you begin the installation, check the AC voltage of your area. The AC power adapter, which is used to supply the DC power for the unit should have the AC voltage matching the commercial power voltage in your area.

### The AC Power Adapter Specifications



AC input power: AC power voltage of your area,  
Rated input options -  
AC120V/60Hz, AC230V/50Hz,  
AC100V/50-60Hz, Rated AC240V/50Hz  
Rated output- DC7.5V 500mA min.

Steps to apply the power to the converters are:

1. Connect power adapter DC plug to the DC input jack located on the back of the converter before connecting to the AC outlet.
2. To ensure against accidental disconnection, tie the DC cable with the cable tie located the back of the converter.
3. Connect the power adapter to the AC outlet.
4. Check Power LED indication.



## 2.6 Making TP Port Connection

TP port is featured to support connection to:

- Auto-negotiation devices
- Auto-negotiation incapable 10BASE-T devices
- Auto-negotiation incapable 100BASE-TX devices

### Network Cables

10BASE-T: 4-pair UTP Cat. 3,4,5, EIA/TIA- 568 100-ohm STP

100BASE-TX: 4-pair UTP Cat. 5, EIA/TIA-568 100-ohm STP

Link distance: Up to 100 meters

### Configuration Setup

To make a proper connection, the following configuration settings are recommended:

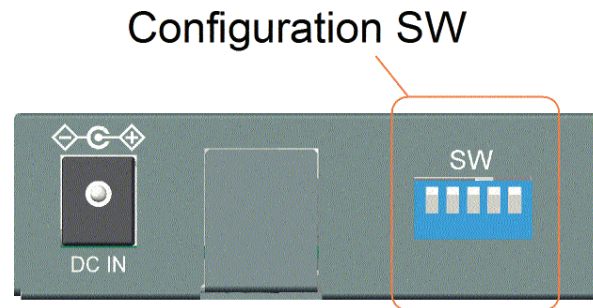

<b>TP port link partner</b>	<b>SW1</b>	<b>SW2</b>	<b>SW3</b>
Auto-negotiation device	Off: auto	Off: full duplex	Off: 100M
Fixed 10M half duplex device	On: forced	On: half duplex	On: 10M
Fixed 100M half duplex device	On: forced	On: half duplex	Off: 100M
Fixed 10M full duplex device	On: forced	Off: full duplex	On: 10M
Fixed 100M full duplex device	On: forced	Off: full duplex	Off: 100M

## 2.7 LED Indicators

### Link Fault Pass Through Function is disabled

LED	Display	Status	Interpretation
PWR	Power status	On	Power on
		Off	Power off
TP LINK	TP port link status	On	Link up and no traffic
		Off	Link fault
		Blink	Rx/Tx activities
TP 100M	TP port speed status	On	100Mbps
		Off	10Mbps
TP FDX	TP port duplex status	On	Full duplex
		Off	Half duplex
		Blink	Collisions on half duplex
FX LINK	FX port link status	On	Link up and no traffic
		Off	Link fault
		Blink	Rx/Tx activities
FX OL	FX port optical link	On	Optical signal is detected
		Off	No optical signal is detected

### Link Fault Pass Through Function is enabled

TP LINK	FX LINK	FX OL	Interpretation
On	On	On	Both TP and FX ports link up
Off	Off	On	(1) TP port link fault or (2) FX port received FEFI signal (FX port Tx path failed.)
Off	Off	Off	(1) TP port link fault or (2) FX port Rx link failure detected

### Remote TP port monitoring

LED	Display	Status	Interpretation
RTP LINK	Remote TP port link	On	Link up and no traffic
		Off	Link fault
RTP 100M	Remote TP port speed	On	100Mbps
		Off	10Mbps
RTP FDX	Remote TP port duplex	On	Full duplex
		Off	Half duplex

## 2.8 Performing Loop Back Test

To perform a loop back test between a local MC and a remote MC connected by a fiber cable, the steps are:

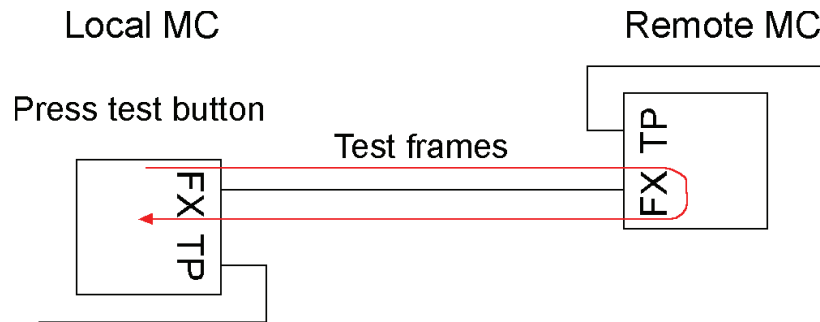

1. Push and press Loop back test button of local MC.
2. Check RTP LINK LED. It blinks to indicate the MC is in loop back test mode.
3. Check RTP 100M LED. It is ON to indicate a complete of loop back test and OFF during test.
4. Check RTP FDX LED for the test result. It is ON to indicate a TEST PASS and OFF for TEST FAIL.
5. Release Loop back test button. RTP LINK/100M/FDX LEDs are back to display remote TP port status.

### Summary of Loop Back Test LEDs

<u>LED</u>	<u>Status</u>	<u>Interpretation</u>
RTP LINK	Blink	The MC is on Loop Back Test mode.
RTP 100M	On	Loop back test complete
	Off	Loop back test in operation
RTP FDX	On	Loop back test Ok
	Off	Loop back test fail

### 3. Optional Configuration Settings

---

The media converter provides additional configuration settings which are user-inaccessible. The settings are built on the board inside the product case. The settings are provided for technical installers to adapt the converter to fit some specific application needs.

#### 3.1 User Inaccessible Jumpers

The setting jumpers are not accessible by users generally. For accessing these jumpers, the upper case must be removed from the product. Removing case must perform by an authorized and experienced technical person. The setting jumper block is located on the position shown below:

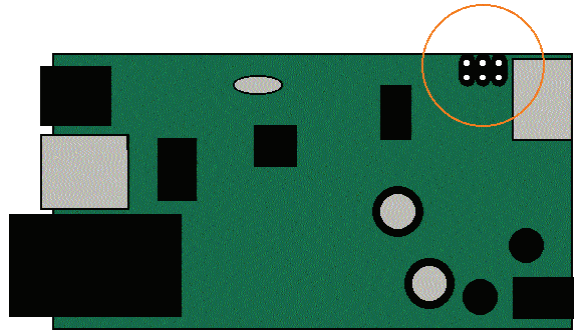

The setting functions are as follows:

JP1	Forwarding mode setting	Open	- Store-and-forward mode
		Short	- Smart-forward mode
JP2	802.3x function setting	Open	- Enable
		Short	- Disable
JP3	FX port duplex setting	Open	- Full duplex mode
		Short	- Half duplex mode

### 3.1.1 Forwarding Mode Setting JP1

The following table lists the forward method used in different TP to FX conversions:

<b><u>JP1 Setting</u></b>	<b><u>TP port to/from FX port</u></b>	<b><u>Forward method</u></b>
Store-and-forward	10BASE-T to 100BASE-FX	Store and forward
	100BASE-TX to 100BASE-FX	Store and forward
Smart-forward	10BASE-T to 100BASE-FX	Store and forward
	100BASE-TX to 100BASE-FX	Direct conversion

On smart-forward mode, the converter can change to direct conversion automatically when it detects same speed on both TP port and FX port. Direct conversion method converts the signal between TP port and FX port without storing the received packet on one port then forwarding to another port. The media converter operates with the minimum latency.

Note:

1. In direct conversion, be sure both devices connected to the TP port and FX port have same duplex mode for proper transmission.
2. In direct conversion, the 802.3x function is disabled and the media converter will not generate pause frame, but just forwards the received pause frame directly from one port to another port.
3. In direct conversion, the media converter is not limited to the maximal length of the receiving packets.

### **3.1.2 802.3x Function Setting JP2**

IEEE 802.3x function is the flow control method used for full duplex operation on TP port and FX port under store and forward mode. This method uses pause frames for one port to stop further transmission from its link partner.

### **3.1.3 FX Duplex Setting JP3**

This setting is used to set the duplex mode of the FX port.

## **3.2 JP1-JP3 Factory Default Settings**

The factory default settings for JP1, JP2, and JP3 are as follows:

JP1	Open Store-and-forward mode
JP2	Open 802.3x function is enabled
JP3	Open FX port full duplex